

Studies at EXTRAP T2R

Sheena Menmuir

Atomic and Molecular Physics, KTH

ADAS workshop 10-13 October 2007

EXTRAP T2R

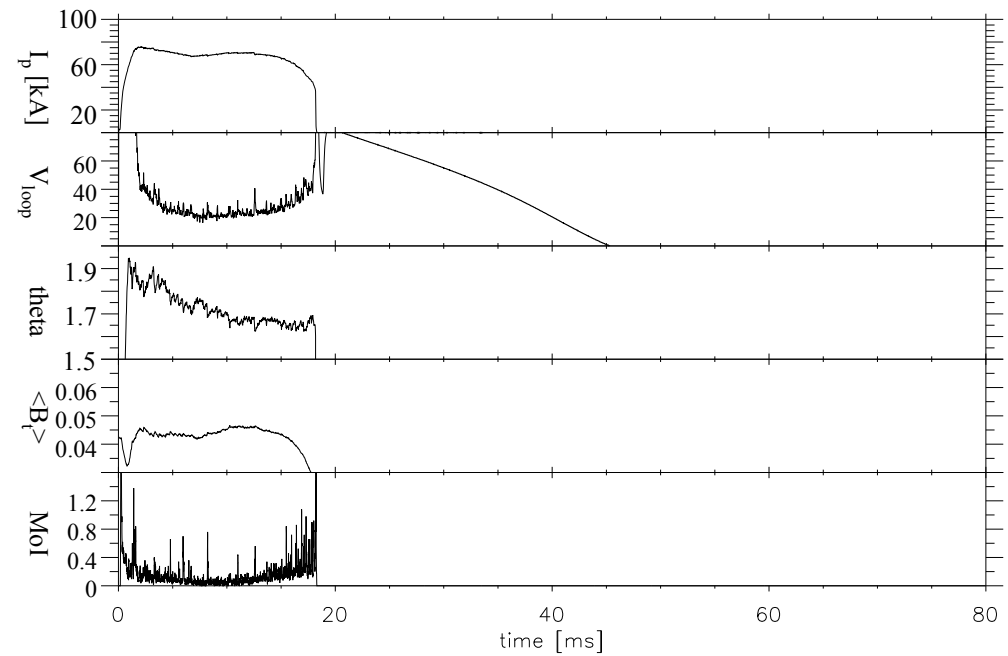
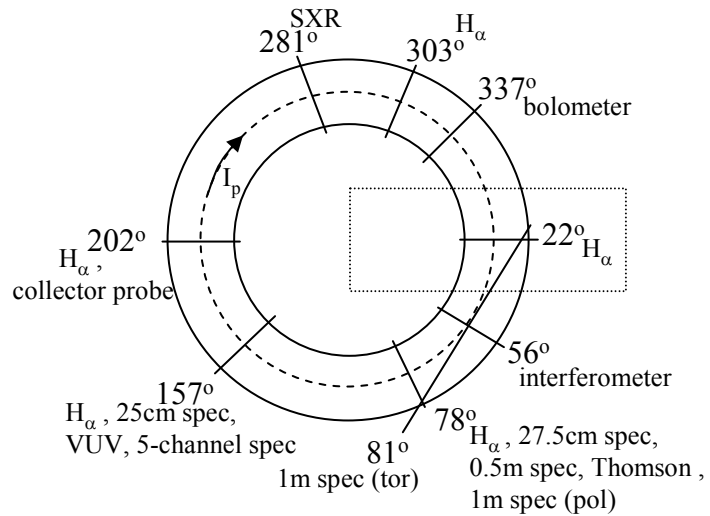
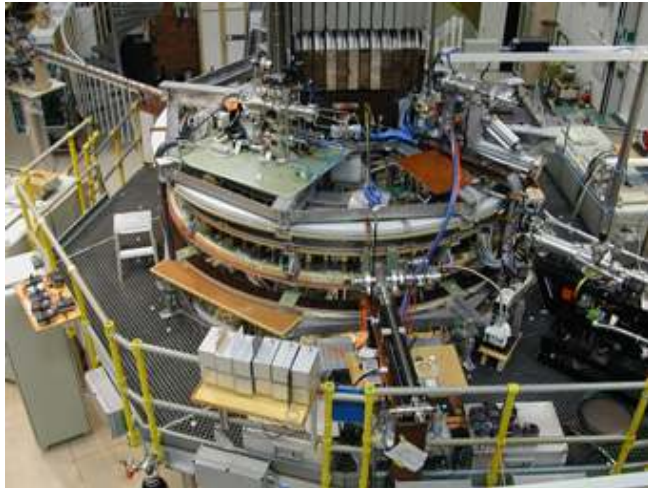

EXTRAP T2R

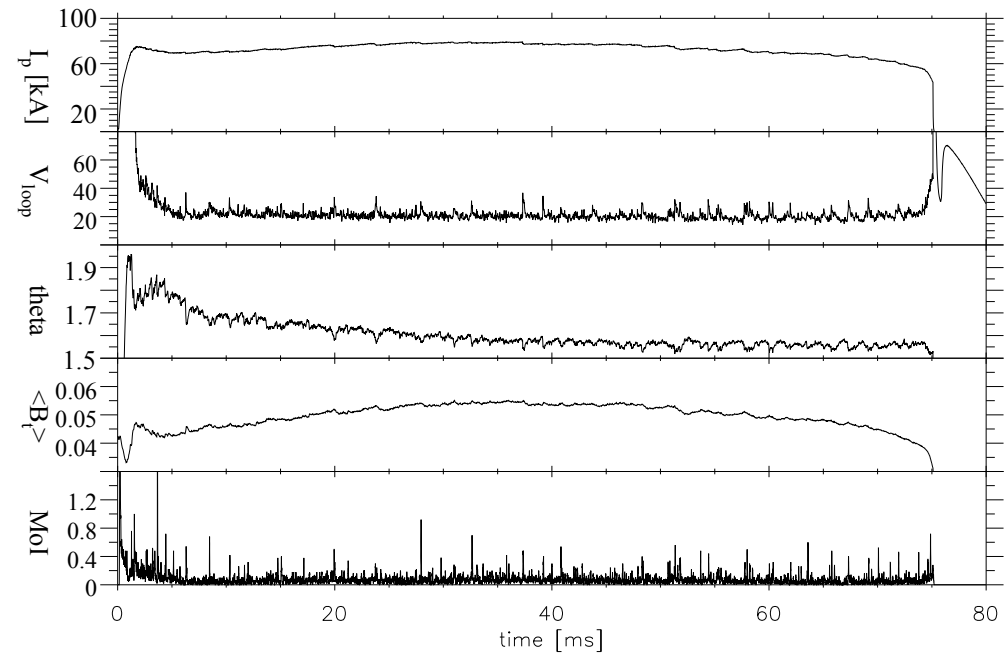
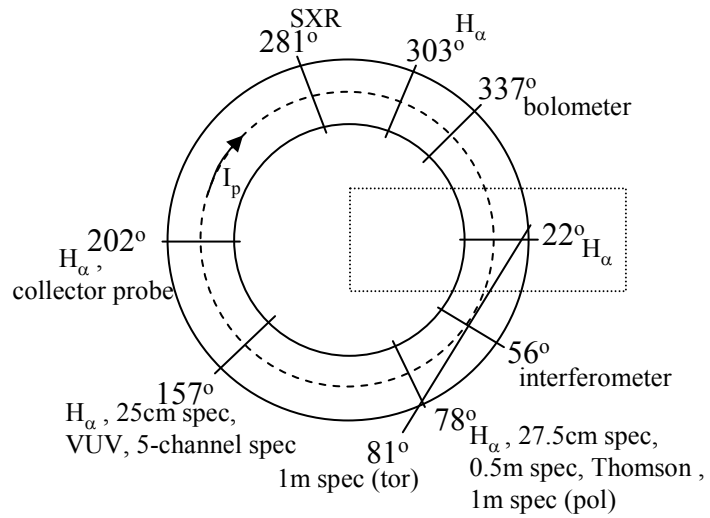
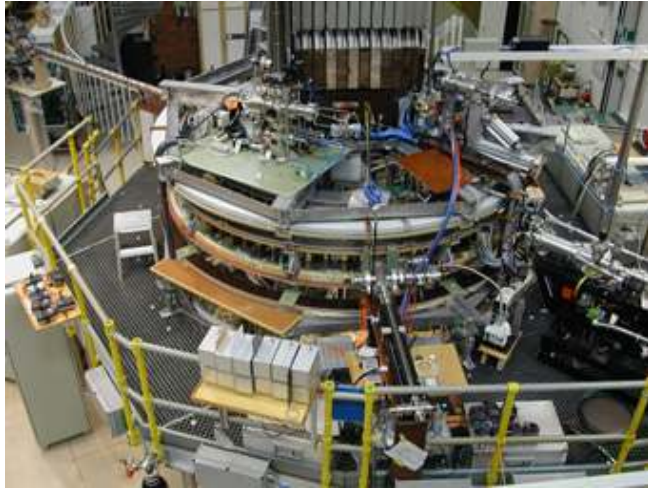

Particle flux

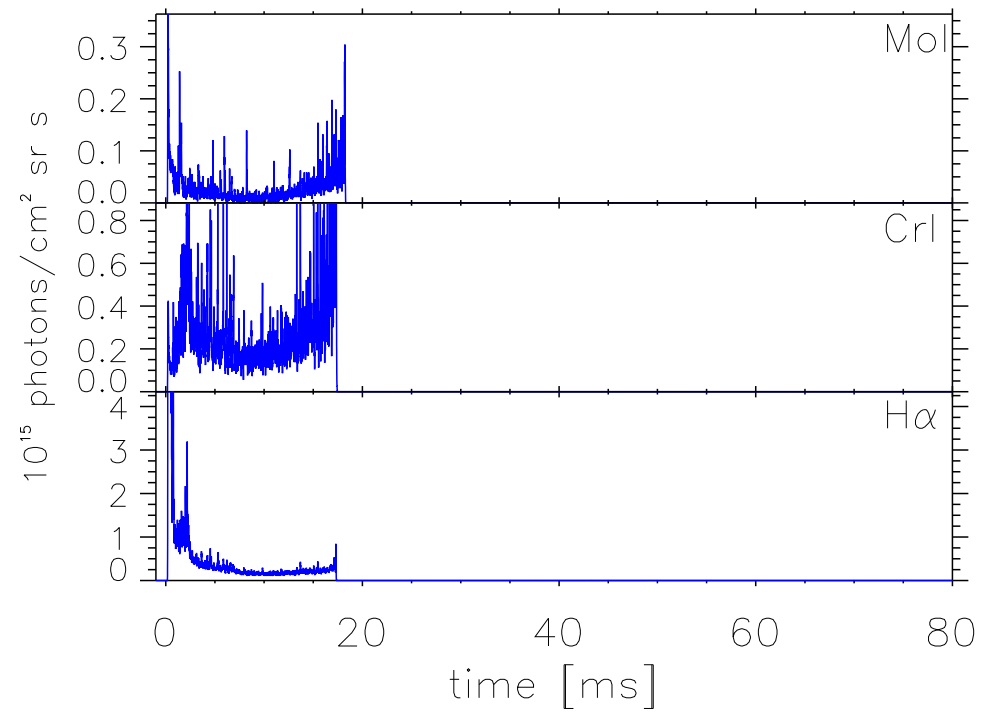

Particle flux

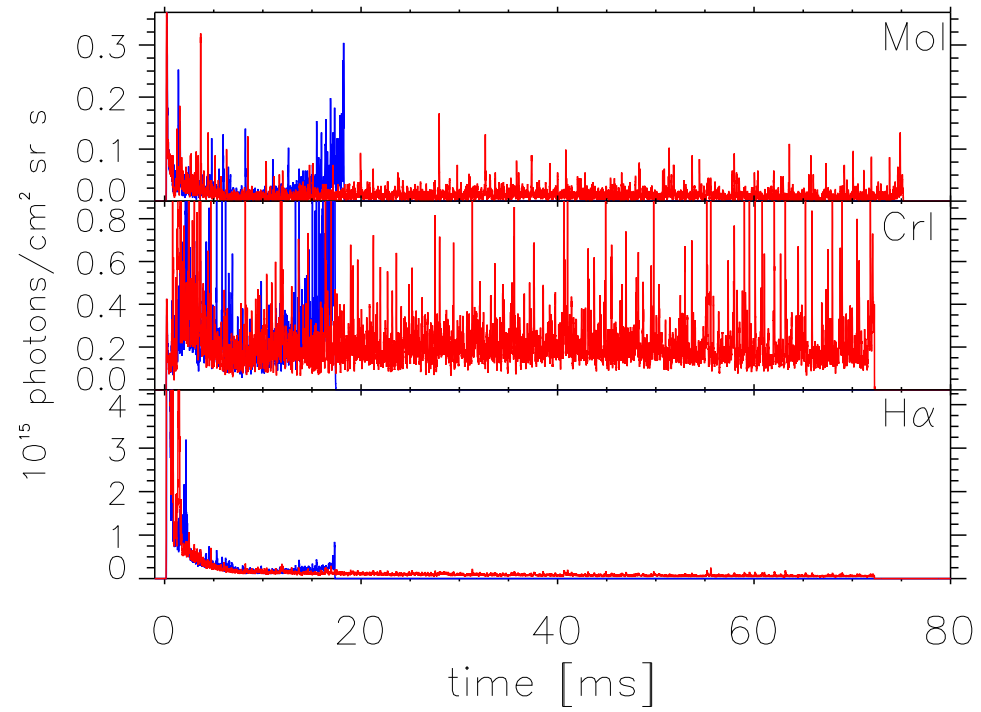

Particle flux

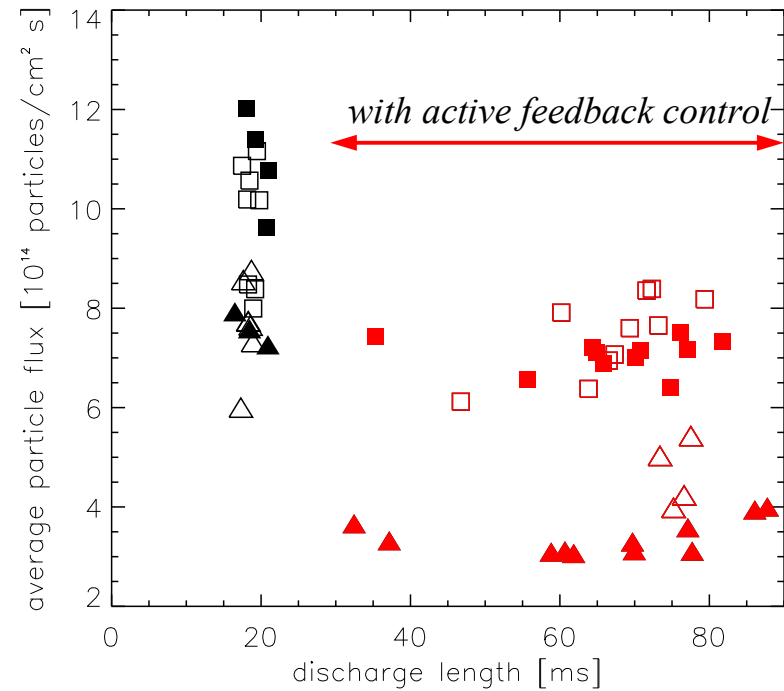
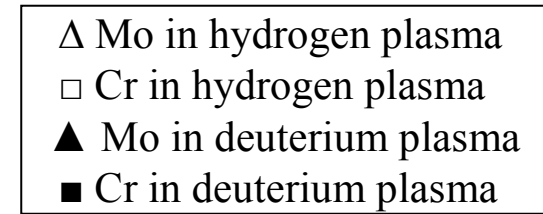
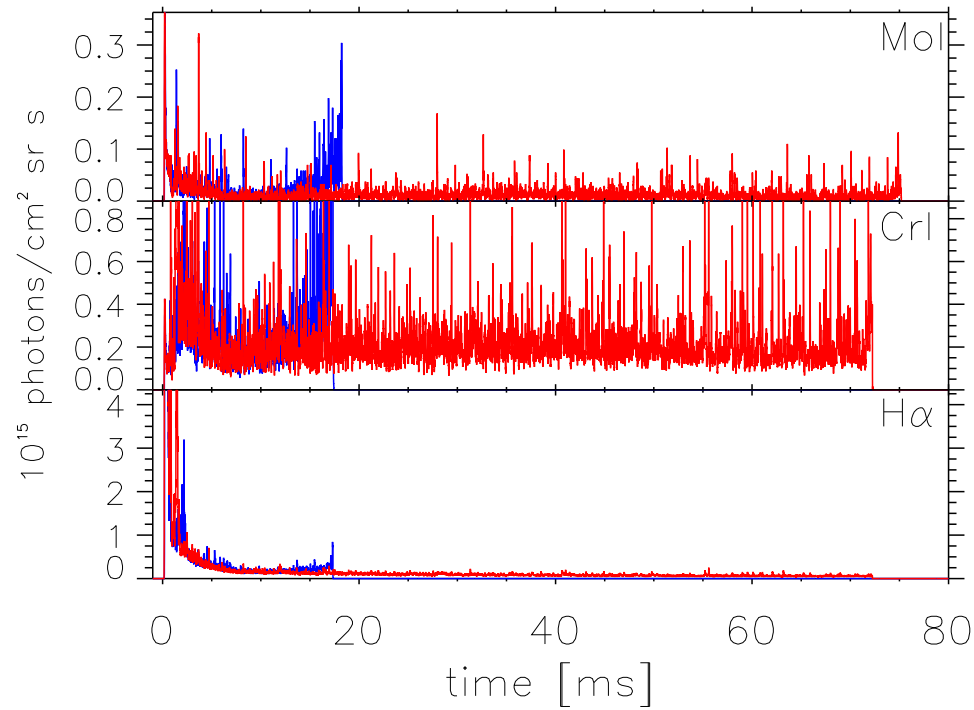

Ion (toroidal) rotation

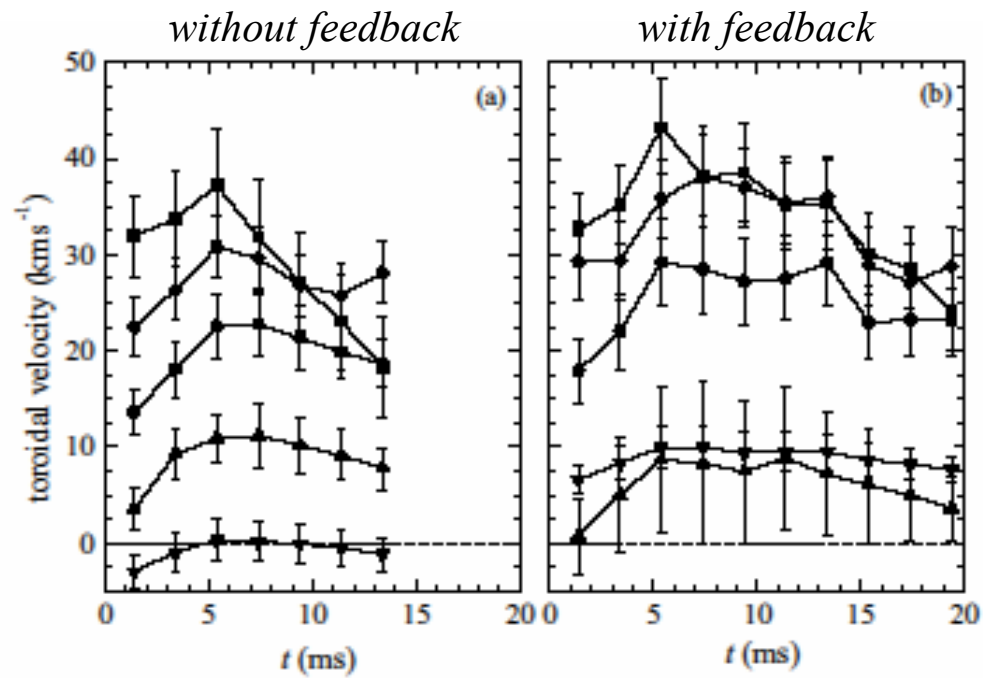
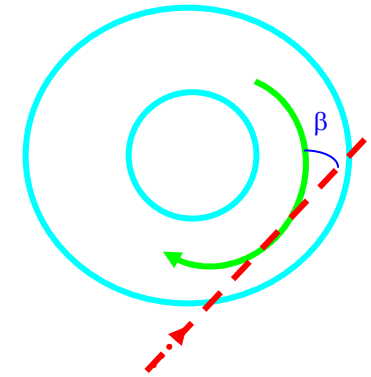

Ion (toroidal) rotation

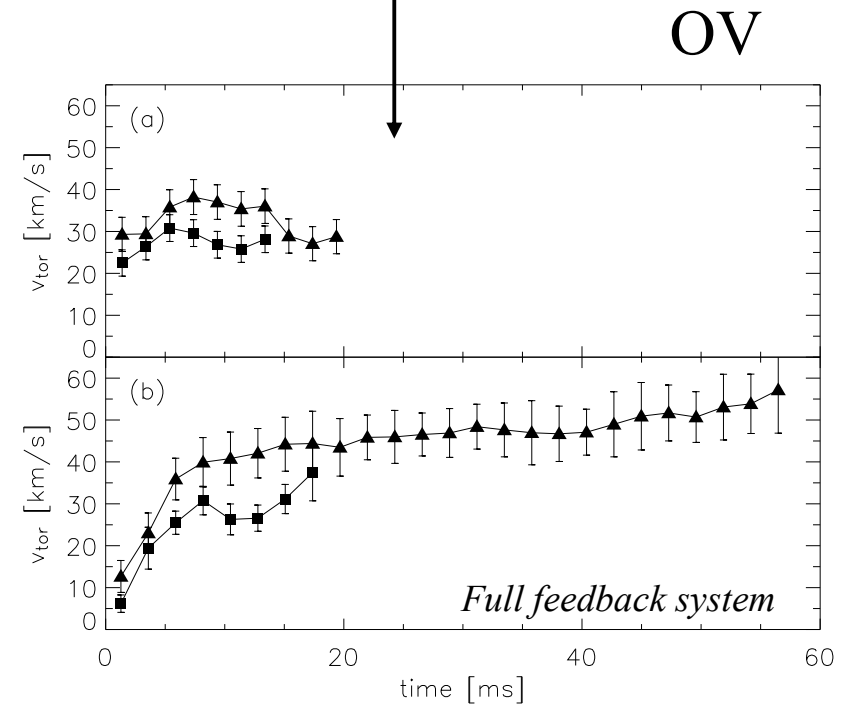
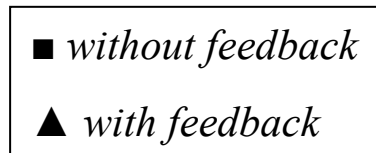
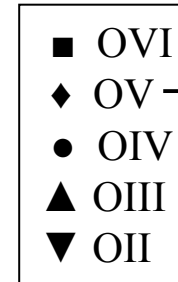
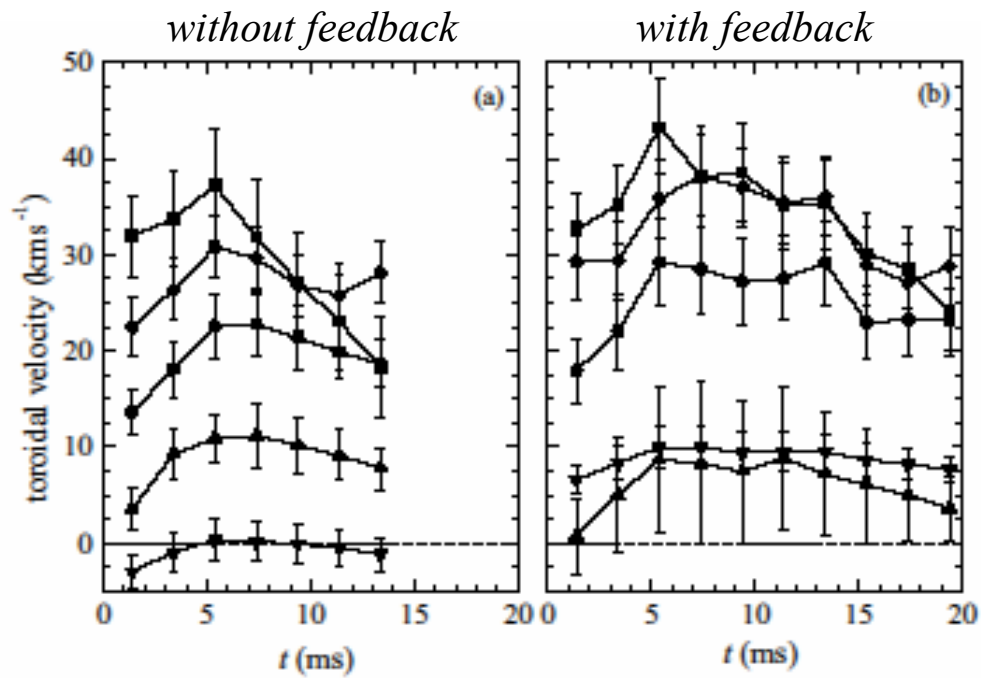
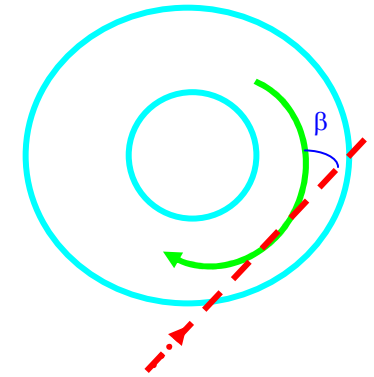

Ion (toroidal) rotation

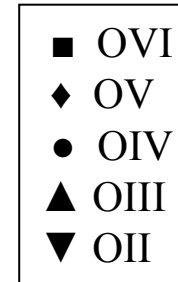
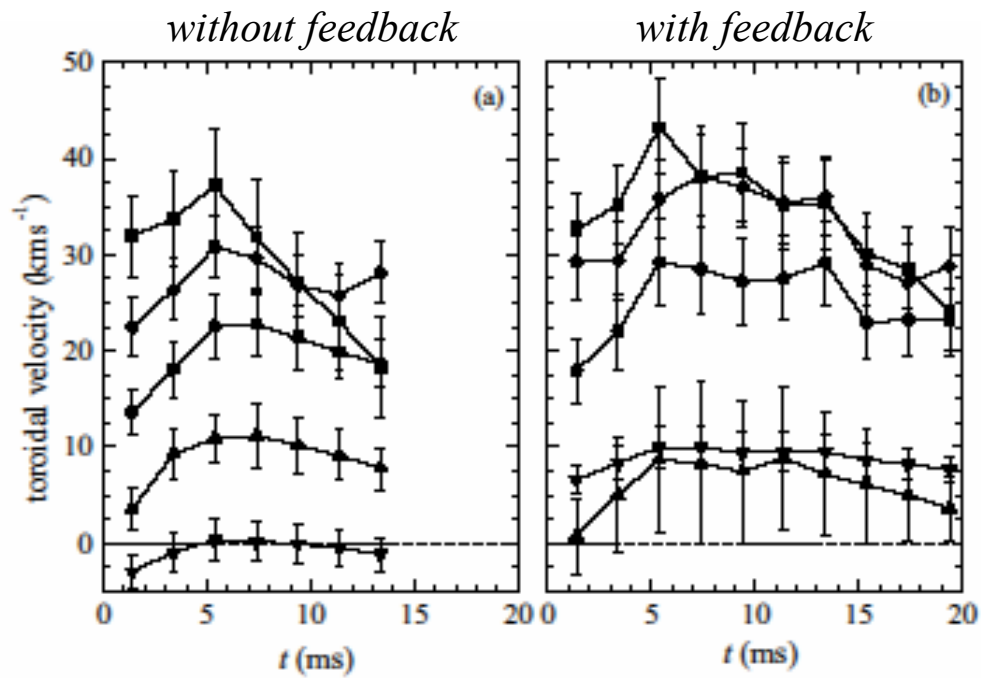
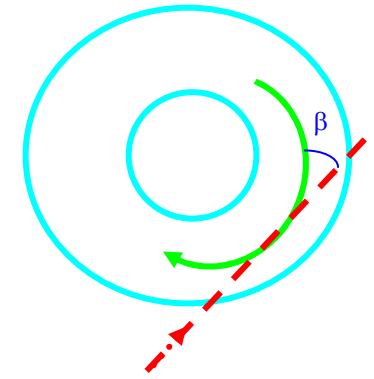

OVI

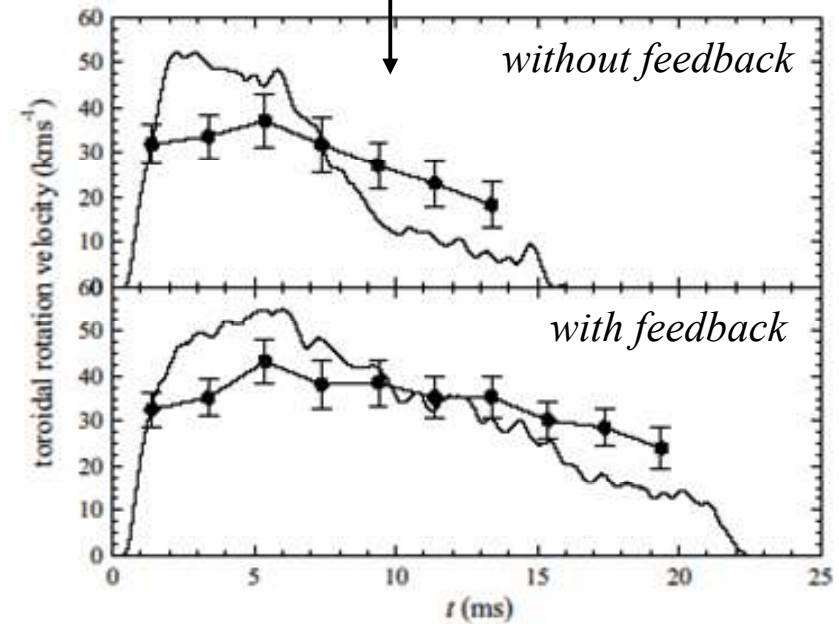

Ion (toroidal) rotation

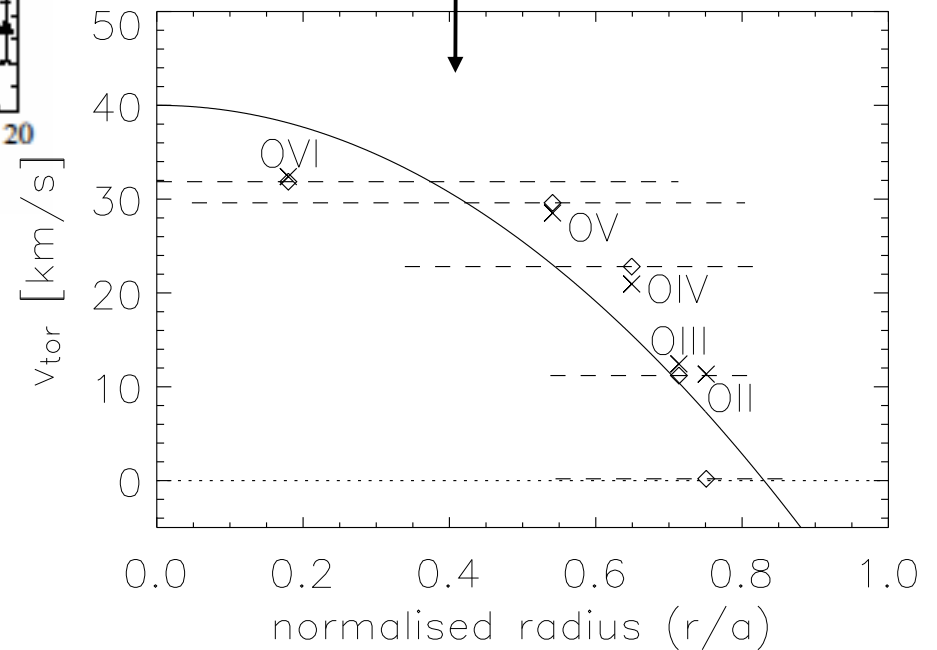
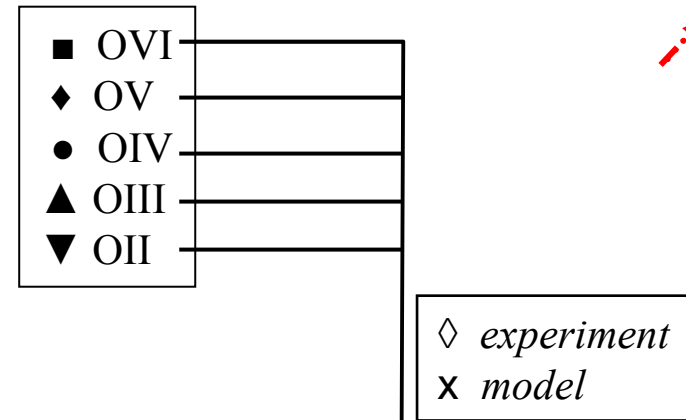
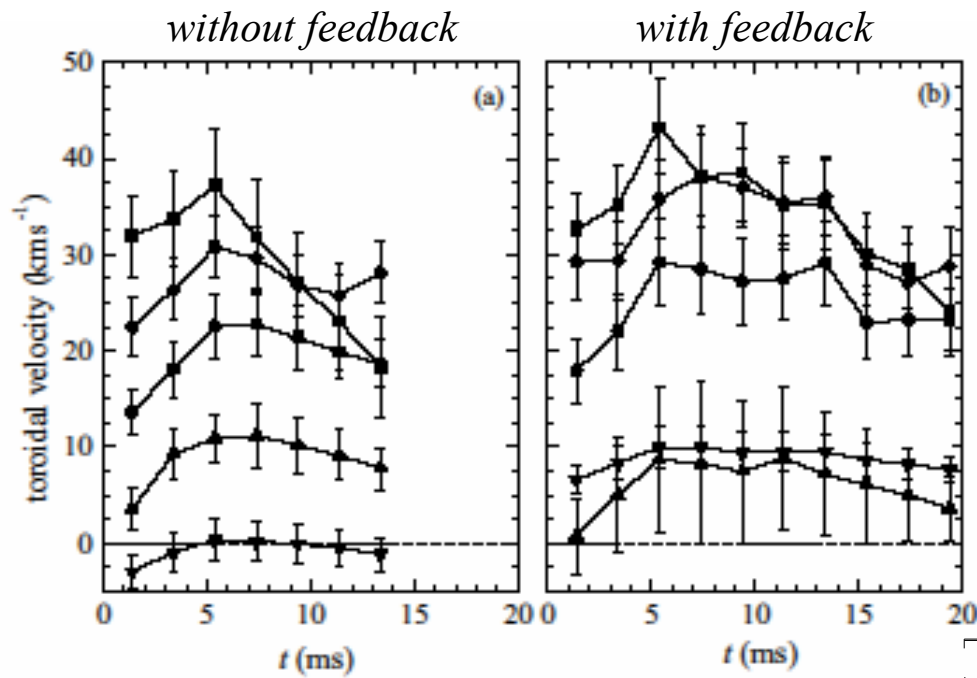
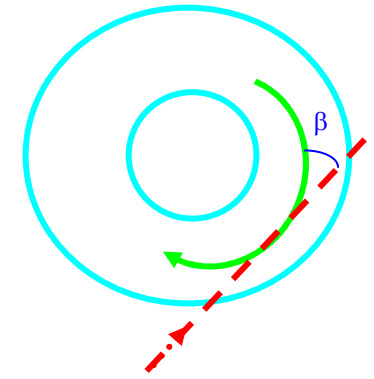

Ion temperature

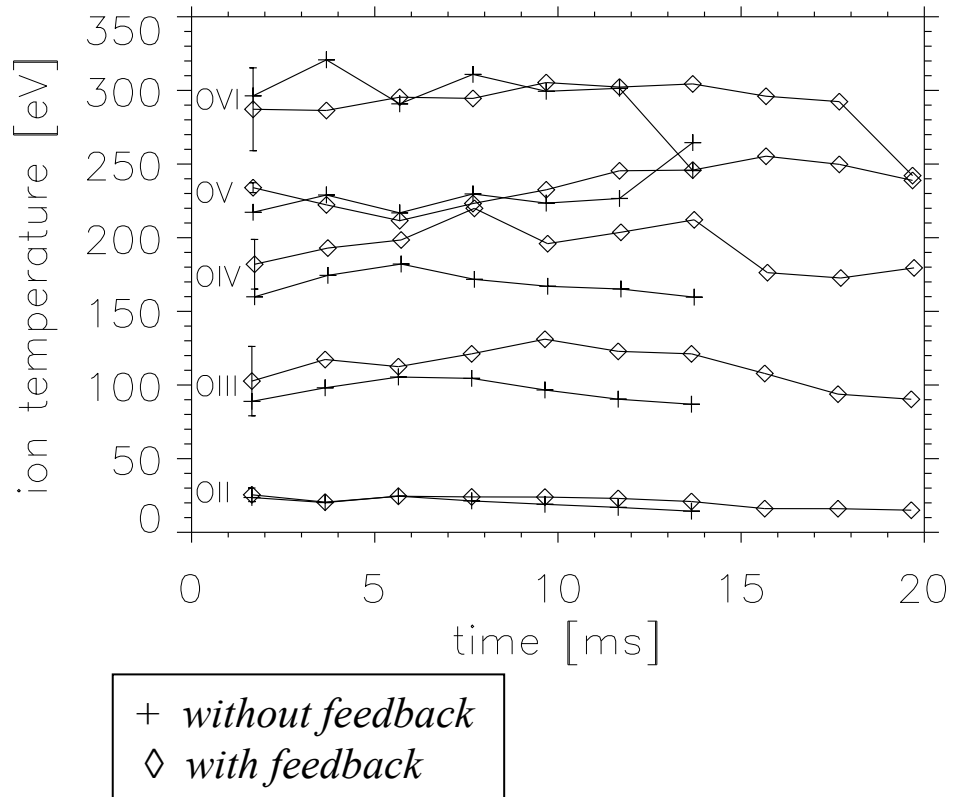

Ion temperature

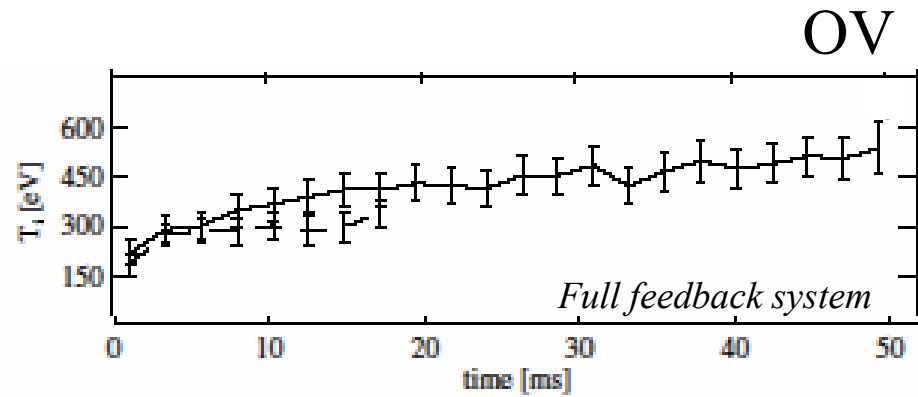
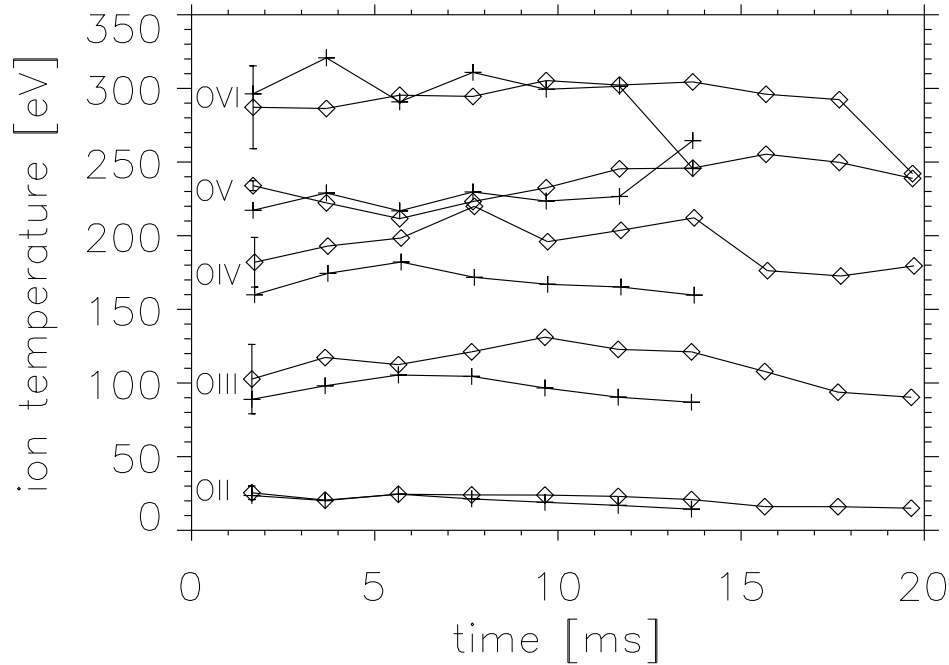

Ion temperature

